



TRIMATIC 22

SISTEMI as always aware of the requirement and problems in woodworking, has created TRIMATIC 22. TRIMATIC 22 is designed for door and window frame makers who manufacture wood/wood-aluminium windows and French windows provided with single/double tilting sash or wing. TRIMATIC 22 allows drilling and manufacturing the seat for angular hinge and upper hinge with a normal pillar drill or a portable electric drill. TRIMATIC 22 is an equipment suitable for drilling holes with a distance between centres of 22 mm. for angular hinges "SIEGENIA" (see Fig. 1).



Fixing of edge hinge

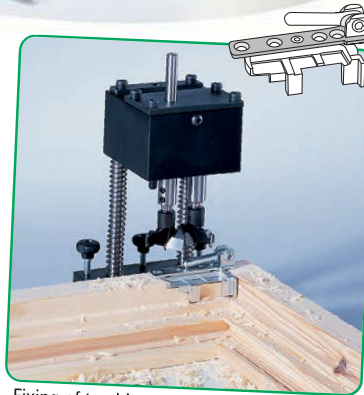

Fixing of top hinge

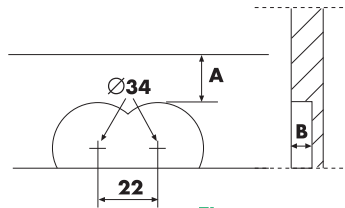
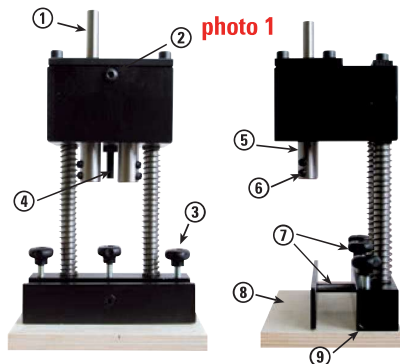

Fig. 1

The equipment as it appears at the time of purchase (see photo 1)



- 1) Fitting for drill spindle
- 2) Threaded hole for greasing
- 3) Locking knob for stop reference rod
- 4) Distance adjusting screw "B"
- 5) Tool holder bush
- 6) Tool locking screw
- 7) Distance adjusting screw "A"
- 8) Equipment support table
- 9) Stop rod sliding hole



www.sistemiklein.com

Equipment setup and operating phases

Disassemble the support table (8) and position the equipment on a surface suitable for the type of work. Procure a rod with $\varnothing 10$ and length suitable for the job to be carried out and insert it in the hole (9). Position the reference stop and lock the whole assembly with the knobs (3). Fix one or more reference blocks on the work surface depending on the length of the door to be drilled. Adjust the screws (7) and (4) (See photo 1) according to the distances "A" and "B" (see Fig. 1). Finally, position the door to be drilled (see Fig. 2)

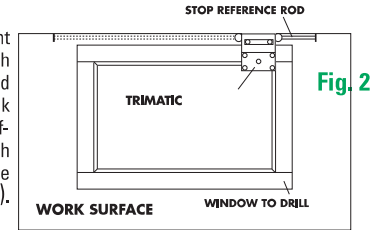

Fig. 2

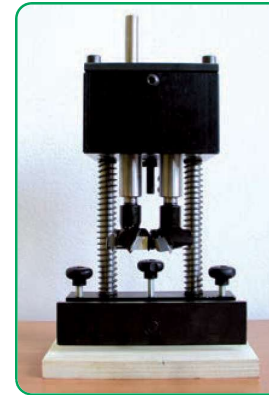

photo 2

HW tools suitable for TRIMATIC 22

- $\varnothing 34$ RH rotation (art. L160.340.R)
- $\varnothing 34$ LH rotation (art. L160.340.L)

Mount the right-hand rotation bit on the bush (4) related to the drill spindle (1) and the left-hand rotation bit on the other bush. lock the bits with the screws (5). - (Photo 2)

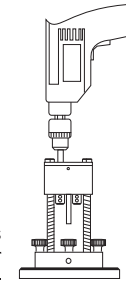
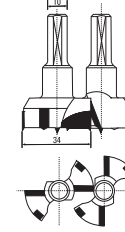
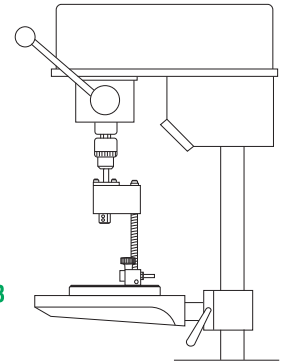

Fig. 3



When the equipment has been set up, all that is required is an electric drill (recommended power 0,75 kw) to be mounted on the spindle (1) or alternatively, a pillar drill may be used (see Fig. 3).

The production range of TRIMATIC also includes

TRIMATIC are dedicated to craftsmen and hobbyists who have drilling problems when fitting hinges or positioning shelves with holes at a distance between centres of 32 mm.

TRIMATIC 43/0 was designed for window frame makers who have problems with drilling holes to fit the handle on wood, wood/aluminium and PVC windows.



TRIMATIC SUPER can be easily and quickly mounted on the multi-spindles head of any automatic boring machine with 32 mm distance between centres chucks.



II TRIMATIC 32 unit with five tool holders is suitable to make a five holes set with distance between centres of 32 mm. in a single pass.

www.sistemiklein.com